



ATSC
DV3
Digital Video
Broadcasting

Digital Video Quality Analyzer DVQ

Always in the picture about picture quality

- Realtime measurement
- No reference signal required
- SSCQE scaling of quality levels
- Monitoring of picture freeze, picture loss and sound loss
- Program decoding
- Integrated MPEG2 decoder
- Histogram representation of quality levels
- Recording of quality profile (long-term)
- Internal event and error report and statistics
- Optional decoding of CA programs



ROHDE & SCHWARZ



With Digital Video Quality Analyzer DVQ, the assessment of picture quality according to subjective criteria becomes an objective realtime measurement method. Picture quality is assessed from artefacts produced by digital compression. The method is based on the analysis of video data and can thus also be used where no reference video material is available. To this end, the optional PC software Quality Explorer™ is available, allowing complete display and analysis of all coding data as well as convenient remote control of DVQ and display of the recorded quality data.

The increasing use of digital, data-compressed TV signals calls for monitoring and assessment of the picture quality. Picture quality assessment is very strongly influenced by the subjective perception of the human eye.

DVQ is a tool that ideally satisfies both requirements. It determines the picture quality in relation to digital compression and evaluates the results according to the subjective criteria of visual perception.

In the year 2000 Rohde & Schwarz won an EMMY Award for DVQ in the category "Pioneering development of equipment to provide objective measurement of perceptible picture quality in digital television systems"



Characteristics

The method adopted for determining the quality is based on the analysis of DCT-coded video data applied to DVQ in a MPEG2 transport stream. The additional SDI input also allows evaluation of decompressed video data.

Another important feature is quality analysis being performed in realtime so that any potential quality degradation can immediately be recognized and remedied. Moreover, this method allows long-term recording, monitoring and evaluation of picture quality.

The unique combination of realtime capability and independence from a reference signal make DVQ an indispensable tool in the quality assessment of digital, DCT-coded video sequences.

Representation of quality levels

The intermediate values determined by video data analysis are differentiated according to luminance (Y) and chrominance (C_b and C_r) (DVQL-U). In a further automatic processing step the quality values are assessed according to the subjective masking effects produced by high temporal and/or spatial activities of the picture. The result of analysis is a reproducible quality level (DVQL-W) from "excellent" (100) to "bad" (0) on a SSCQE scale (see box) that is optimally adapted to the subjective picture perception.

The four parameters obtained can be read out in the following display modes:

- Bargraph (see front view of DVQ)
- Numeric display
- Long-term profile (FIG 3a)
- Histogram (FIG 3b)

For long-term recording of the quality levels, a time between 5 seconds and 5 hours can be selected.

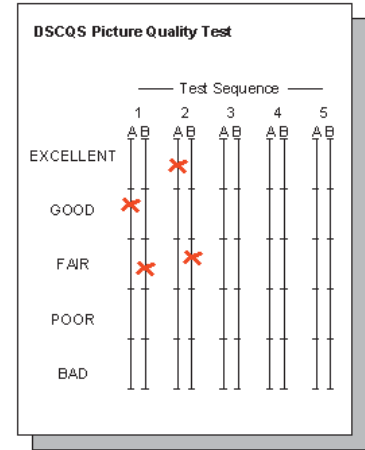
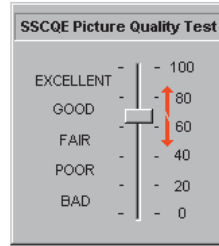

FIG 2: Quality scale for comparative (DSCQS) and absolute (SSCQE) subjective assessment of picture sequences

To make subjective quality ratings comparable, ITU (International Telecommunication Union) has specified two main test methods: the DSCQS (double stimulus continuous quality scale) method is exclusively used for comparative quality assessments. The SSCQE (single stimulus continuous quality evaluation) method is based on a single observation of the sequence to be assessed.

During the presentation the test person moves a slider on a scale from 0 (bad) to 100 (excellent) according to his/her subjective impression of picture quality. This method can be used when no original sequence is available as a reference and corresponds better to the real-life situation of the TV viewer who cannot see the picture recorded in the studio and to the measurement method implemented in DVQ.

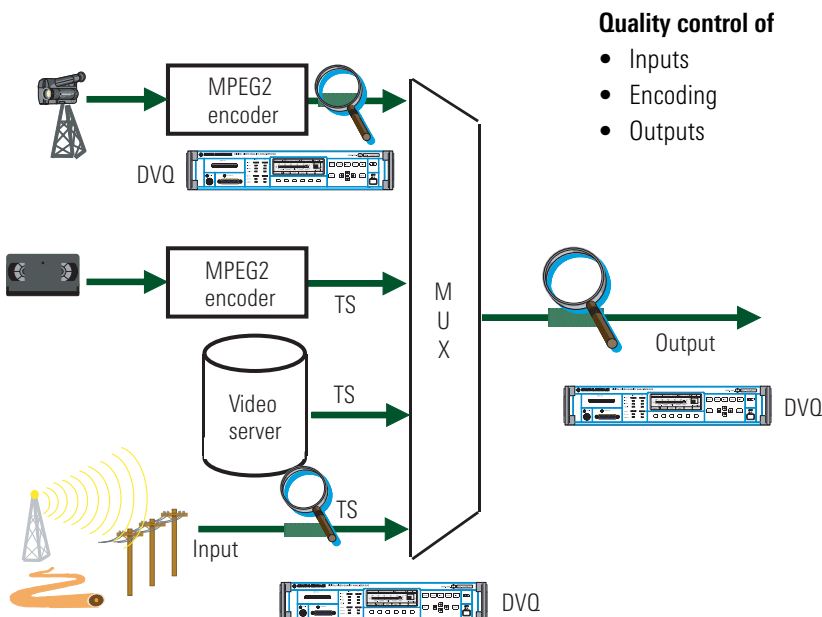

FIG 1: Playout center

Recording of broadcasting failures

DVQ also detects and signals failures such as picture freeze, picture and sound loss (left and right separately) as well as failure to reach a defined minimum picture quality. All these events are continuously recorded in realtime in a report (FIG 3d) stating time, duration, program concerned, etc. Representation of the report can optionally be filtered according to the type of event. In this way any type of interference can exactly be reproduced and analyzed at a later date.

In addition to the report, events are also recorded according to the type of event with error seconds of the failures (FIG 3c). Moreover there is an overview of all programs contained in a transport stream and of their current status regarding failures and picture quality.

Decoder

In addition to the analysis unit, DVQ also has a built-in decoder for audio and video data in the format Mainprofile @ Main-Level and 4:2:2 Profile @ MainLevel. The program being analyzed is decoded and can simultaneously be viewed on a connected video monitor (CCVS or ITU-R 601 or SMPTE259M formats). The audio signals are available at the connectors both in analog and digital form (AES/EBU).

Alarm outputs

Altogether 12 relay outputs which can be allocated to one or several (ORed) events are fitted as standard. The switching mode (active when open or closed) can be set separately for each relay. In addition to the data interfaces, floating switching contacts are thus available for external signalling of failures and quality degradations.

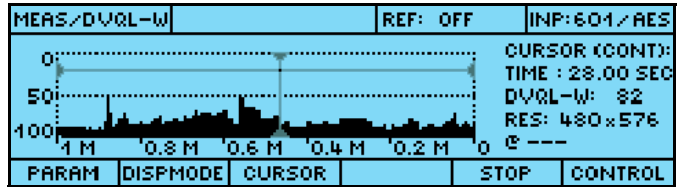

FIG 3a: Long-term profile

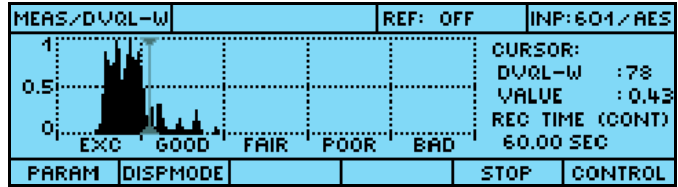

FIG 3b: Histogram

MEAS/STATIST	SCAN: ONCE/ALL/ 35 SEC	INP: ASI-F
[001] PICT LOST	[000] TS SYNC LOSS	
[007] PICT FREEZE	[000] VIDEO SYNC LOSS	
[032] DVQL-W LIMIT	[000] AUDIO SYNC LOSS	
[---] SND LEFT LOST		
[005] SND RIGHT LOST		
	REF	STOP CLEAR

FIG 3c: Error statistics

MEAS/REPORT	SCAN: ONCE/ALL/ 35 SEC	INP: ASI-F		
NO TIME	EVENT	VALUE(S)	PID	REF
000 10:37:45	DVQL-W LIMIT	59/	8.8 SEC	4660
001 10:46:18	SND LEFT LOST	---/	10.5 SEC	4664
002 10:57:06	PICT FREEZE	---/	5.8 SEC	4660
003 11:06:27	PICT FREEZE	---/	6.8 SEC	4660
FIRST	LAST	FILTER	STOP	CLEAR

FIG 3d: Time-related report

Scan mode for several programs

An MPEG2 transport stream usually contains several programs made up of video and audio data streams. For automatic monitoring of all programs, a scan mode is provided in DVQ allowing all or selected programs to be successively analyzed for picture quality and interference over a se-

lectable period of time. The threshold values for the detection of picture freeze, picture and sound loss as well as the minimum value for picture quality can be set separately for each program in the scan mode. Plus, the user can select – for each of these tests and separately for each program – after how many scans with consecutive errors a given error is to be recorded and processed. Thanks to these two setting facilities, monitoring can be optimally adapted to the specific characteristics of each program transmitted.

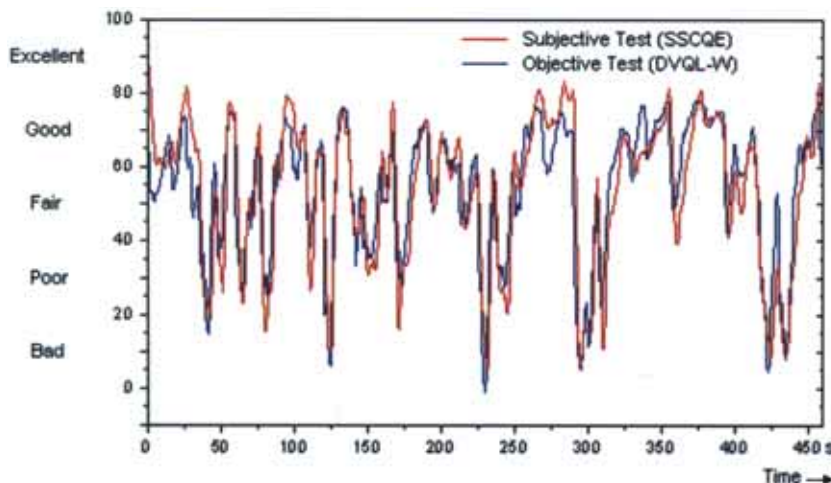

FIG 4: Comparison of objective test results (DVQL-W) and subjective quality assessments (SSCQE) for 480 s sample sequence

Comparative measurements

For comparative quality measurements the quality analysis can simultaneously be carried out on two different signals. Quality analysis is carried out completely independently for each signal and the final result is formed from the differences found. There is no pixel comparison of two video data sources in this mode either. The reference signal as an uncompressed SDI video stream (to ITU-R 601/656 or SMPTE259M) or as a transport stream (ASI, SPI, or SMPTE310M with option DVQ-B3) is applied to the DVQ input that is not occupied by the signal to be analyzed. DVQ automatically detects and compensates for any delay of up to ± 5 s between the reference and the test signal.

Operation

DVQ can be controlled manually via the keypad with fast-access keys for the main menus and softkeys for the submenus. The displayed contents of the clearly arranged LCD is inserted into the decoded picture at the video output. With a recorder connected the quality ratings can be logged together with the associated picture contents.

Remote control

DVQ features full remote-control capability via the RS232 or Ethernet interface using the same commands in SCPI language. When using the Ethernet interface, the TCP/IP and SNMP protocols are available.

DVQ has a built-in 32 Mbit memory for transport stream data. Depending on the data rate of the video stream, the memory is sufficient for storing a video data sequence of approx. 5 to 10 seconds. The sequence can be read out for in-depth analysis via one of the remote-control interfaces using for instance the Quality Explorer™ (see data sheet PD 757.5450).

Applications

The unique combination of realtime capability and independence from a reference signal opens up a wide field of applications for DVQ. Long-term recording and evaluation allows quality assessment that is closer to reality than that of short standardized test sequences.

Quality monitoring in distribution networks

DVQ allows the picture quality to be monitored during program transmission and in realtime. Degradations in quality and failures can be recognized at an early stage so that remedial measures can be taken in time. Since the analysis method employed does not require any reference signals, DVQ is suitable for use wherever MPEG2-coded video data are transmitted or received.



FIG 5: Clearly visible blocking effects on digitally coded TV picture and – by comparison – picture without blocking

DVQ can be used to document the picture quality versus time at the gateway between two different networks. This could for instance be used as an evidence for the contractual performance of services.

The network compatibility of DVQ ensures optimum integration into monitoring systems.

DVQ in conjunction with DTV Recorder Generator DVRG (see data sheet DVRG PD 757.5708) and, optionally, Realtime Monitor DVRM (see data sheet DVRM PD 757.5566) forms a complete monitoring system with recording capability even for very rare disturbances. The relay outputs of DVQ and DVRM are connected with the trigger input of DVRG, whose elaborate trigger characteristics make it possible to record a transport stream section of arbitrary length before and after an error event for subsequent detailed analysis.

Program quality assessment

Again it is a benefit that the measurement method is based on the analysis of video data and does not need reference pictures. Instead of lengthy observations carried out by a test person, unknown program material can automatically be checked for its picture quality.

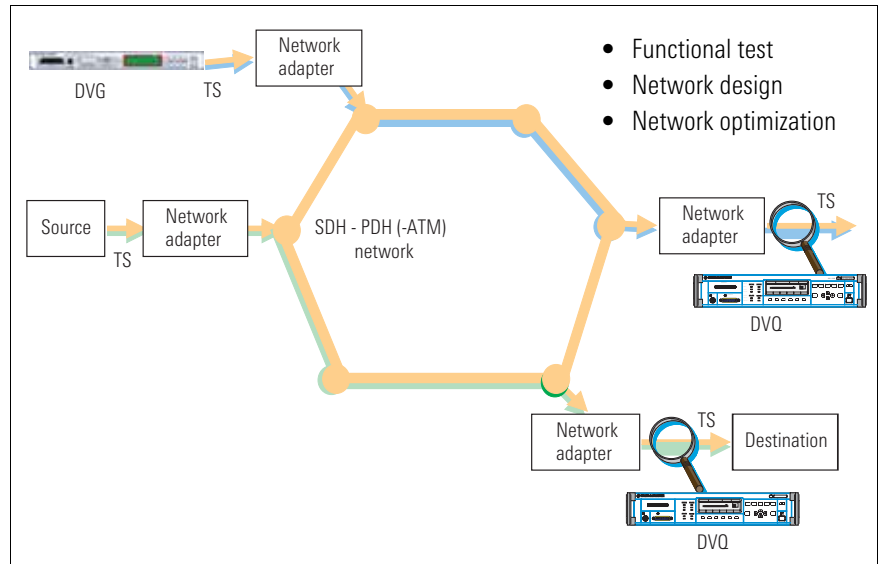

FIG 6: Network monitoring

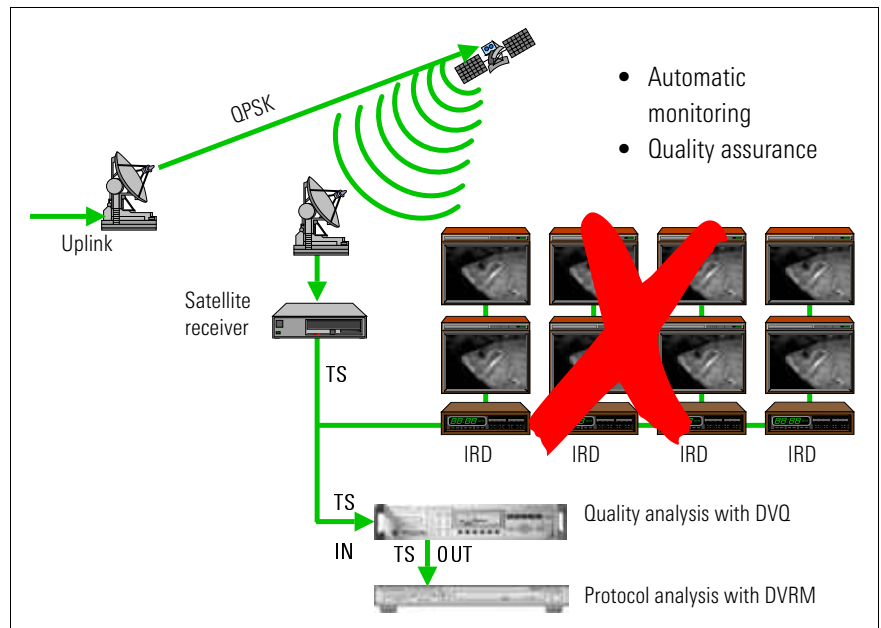

FIG 7: Satellite uplink

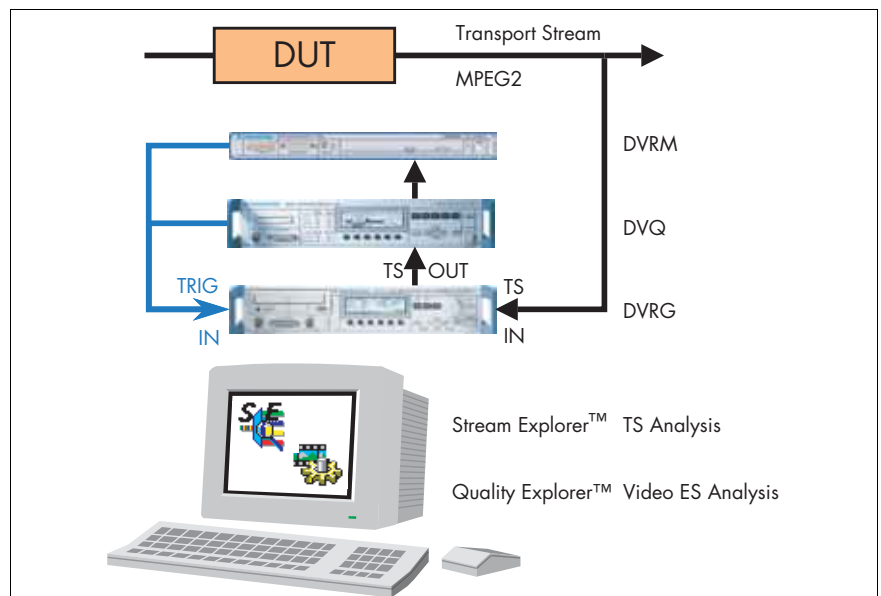

FIG 8: Error analyses with DVRG and realtime analyzers

Development as well as evaluation and setting of operational hardware

In the following application examples comparative quality measurement is mainly used since the changes in picture quality are of significance.

DVQ provides fast and automated evaluation of encoder algorithms and multiplex methods. The advantage here is that the evaluation is made according to subjective aspects under real conditions of use and with real program material.

Furthermore DVQ provides the means of optimizing the operational settings so that transmission can be as efficient and with as little resources as possible (low data rate), whilst maintaining the required minimum quality.

Testing of set-top boxes

The effects of the receiver and internal processing on picture quality can conveniently be determined with the aid of DVQ.

To this end, the MPEG2 transport stream is tapped at the common interface of the set-top box using a suitable adapter (SFQ-Z17). The artefacts in the test signal produced by coding can be excluded from analysis when using the reference mode.

Thanks to its two remote-control interfaces DVQ can ideally be integrated into automatic production environments and systems.

Options

CA Descrambler DVQ-B1x

Pay TV programs are as a rule transmitted in scrambled form to protect them against unauthorized access. Different CA systems are used, and the programs have to be descrambled accordingly to be able to analyze, decode and display the picture and sound contents same as unscrambled contents.

DVQ comes with options for the most common CA systems. The options incorporate a card reader, whose slot is provided on the front of the unit. It takes up the smart card that is issued by the broadcaster of the program in question and

serves as the subscriber's identity card. The smart card is not included in the DVQ-B1x options but has to be provided by the user.

Each DVQ can take up one CA option. With the required smart card inserted, the option descrambles the picture, sound and teletext contents of a program contained in a transport stream applied to the DVB/ASI input. The same transport stream with descrambled contents is available at the option's DVB/ASI output.

CA systems	Option
Conax	DVQ-B10
Nagravision	DVQ-B10
Viaccess	DVQ-B10
Irdeto	DVQ-B11
SECA-Mediaguard	DVQ-B12
NDS-Videoguard (BSkyB)	DVQ-B15
Betacrypt BetaDigital DTAG ORF	DVQ-B16
Cryptoworks	DVQ-B17
Other systems on request	

SMPTE310M Interface DVQ-B3

This option is a serial interface to SMPTE310M standard for ATSC. It replaces the TS/ASI input on DVQ's front panel.

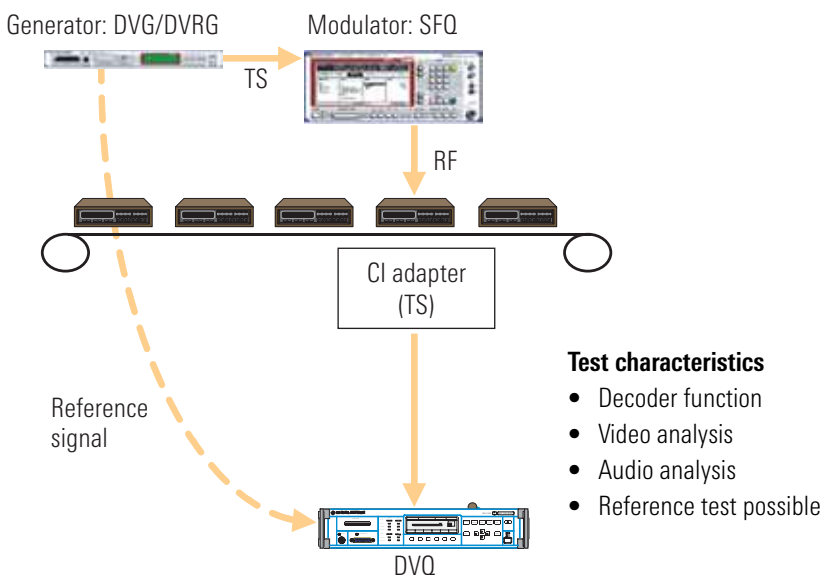

FIG 9: Production of set-top boxes

Quality Explorer™ DVQ-B1 software

The optional software package is installed on an external Pentium II PC and connected to DVQ via the serial or Ethernet interface. It allows in-depth display, analysis and decoding of the coded video data in MPEG2 format down to bit and byte level.

The following display modes are possible:

- Header and extension data at sequence, group and picture level
- Information at picture, slice and macro block level
- Type, DC value and motion vectors per macro block
- Macro block statistics and decoding of each individual macro block

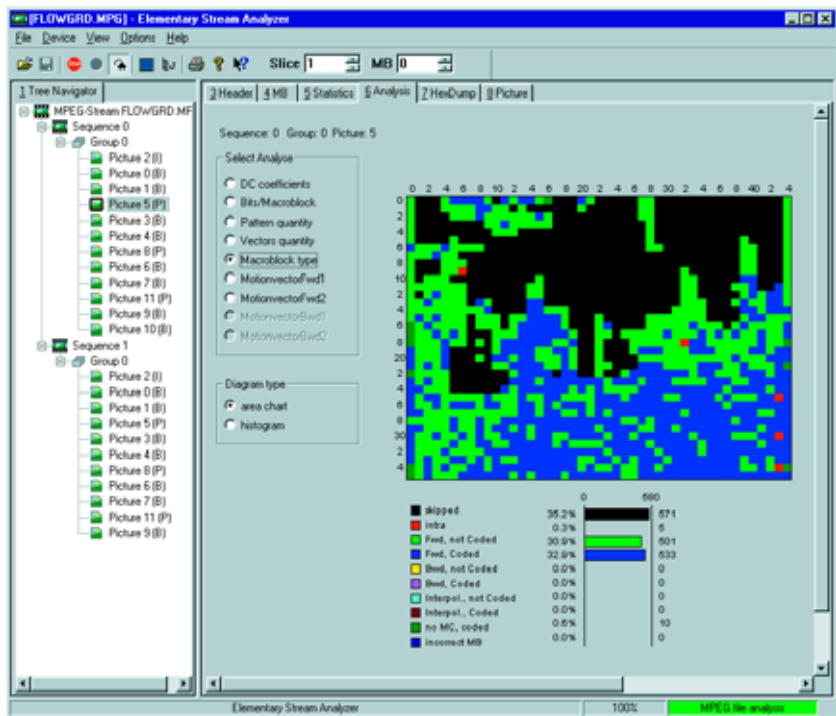

FIG 10: Statistical evaluation over entire frame according to macro block type

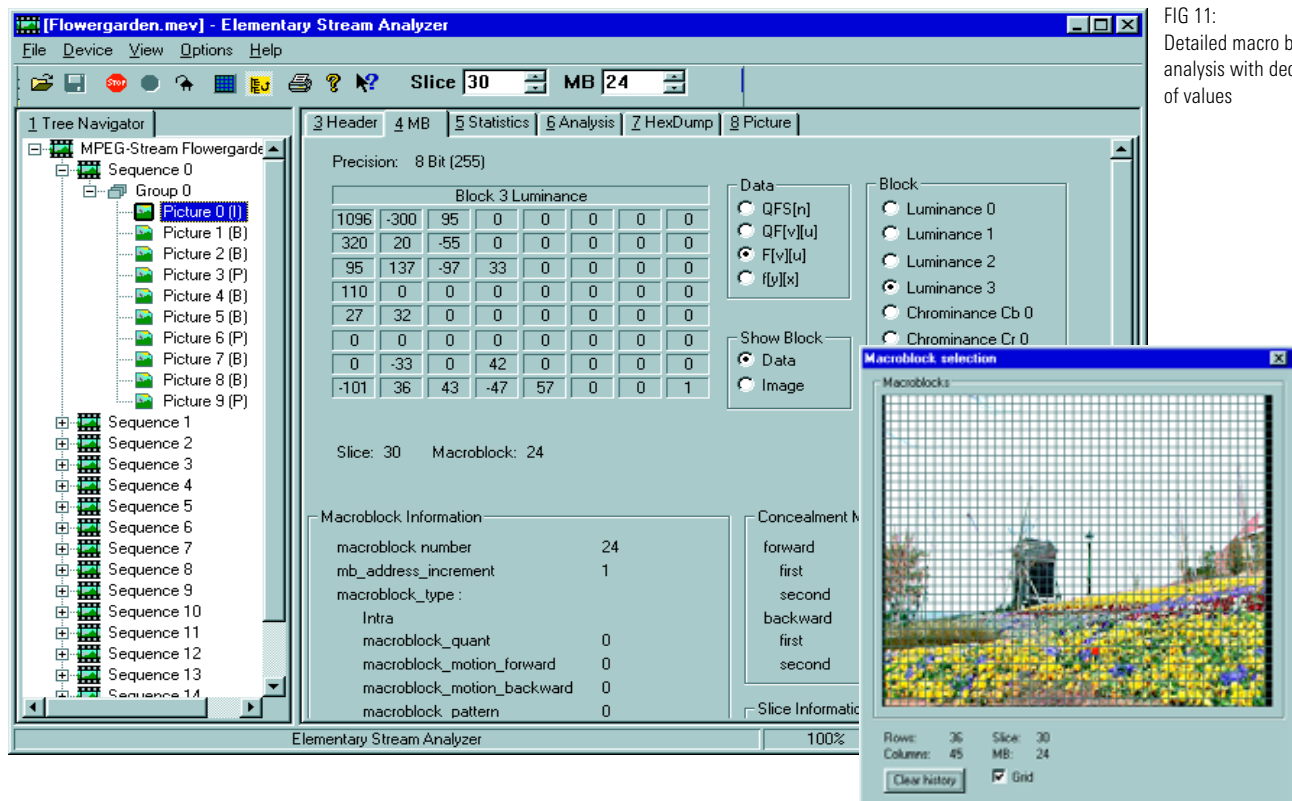

FIG 11: Detailed macro block analysis with decoding of values

Software Quality Monitor™

This is a free-of-charge extra for DVQ which allows remote control of the unit and reading of measured values (tempo-

ral and spatial activities, data rate, DVQL-W quality values) from an external Windows-operated PC. DVQ is connected to the PC via serial or Ethernet interface. Measured values can be continuously

stored in a data memory and graphically displayed using a compatible interchange format (CSV) (FIG 12).

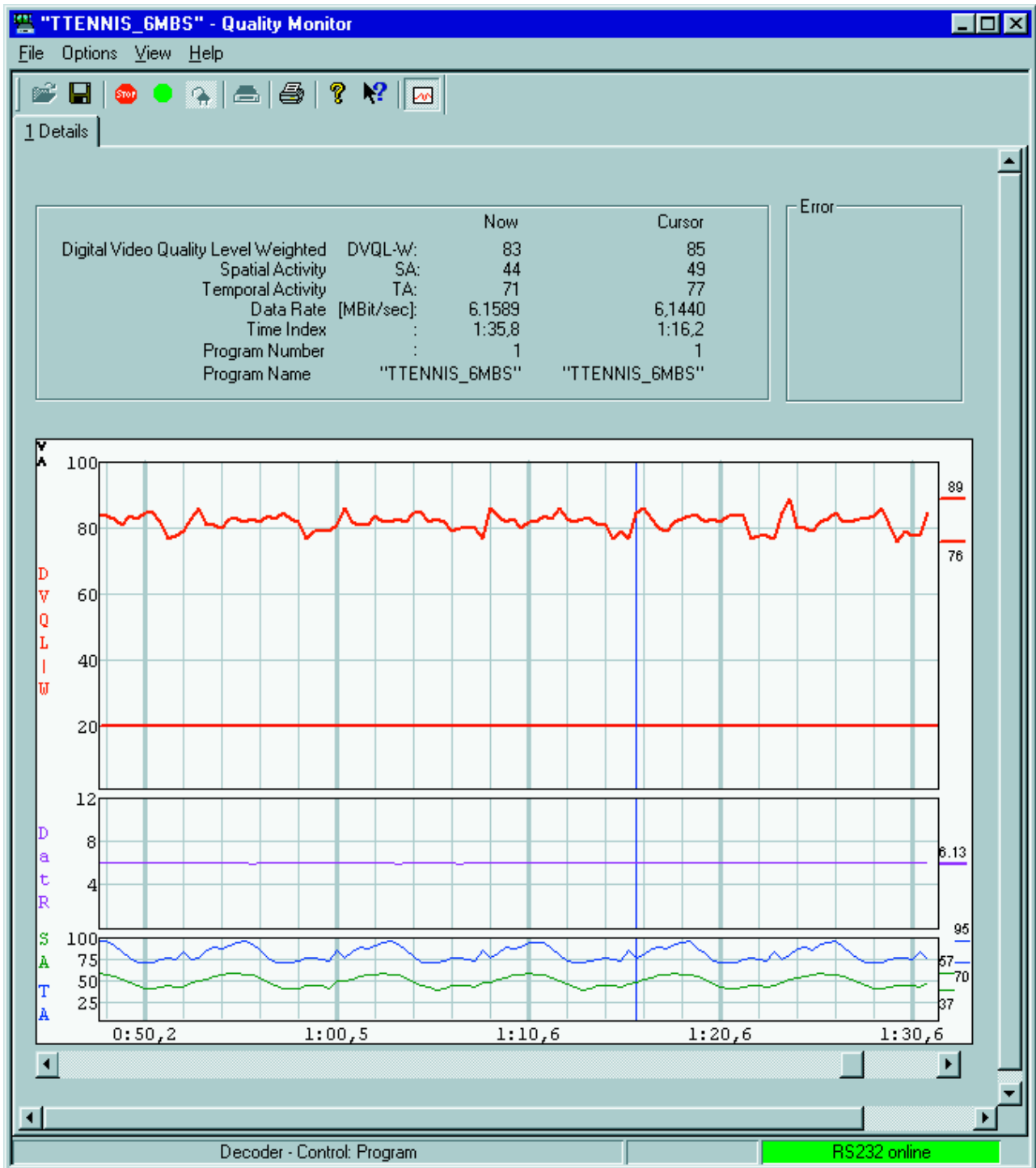

FIG 12: Measurement value presentation with Quality Monitor

Specifications

Signal inputs

MPEG2 transport stream	to ISO/IEC 13818-1
Length of data packets	188/204/208 byte
Synchronous parallel (SPI-LVDS, to DVB-A010) Data rate	25-pin connector on front panel 100 mV to 2 V (V_{pp}), 100 Ω up to 80 Mbit/s
Asynchronous serial 270 Mbit/s (ASI, to DVB-A010) Data rate	BNC connector on front and rear panel 200 mV to 1 V (V_{pp}), 75 Ω up to 72 Mbit/s
Synchronous serial (SSI, to SMPTE310M) Data rate	BNC connector on front panel with DV-B310 option 19.392658 Mbit/s, ± 500 Hz
Video serial digital 270 Mbit/s (SDI, to ITU-R 601/656 or SMPTE259M)	BNC connector on rear panel to SMPTE259M
Audio serial digital (AES/EBU)	LEMO Triax connectors on rear panel 400 mV to 12 V (V_{pp}), 110 Ω

Signal outputs

MPEG2 transport stream	to ISO/IEC 13818-1
Asynchronous serial 270 Mbit/s (ASI, to DVB-A010)	BNC connector on rear panel looped through from input
Video CCVS (PAL, SECAM, NTSC, MPEG2 transport stream)	BNC connector on rear panel 1 V $\pm 1\%$ (V_{pp}), 75 Ω $\pm 2\%$ (measured on 20T signal) ± 30 ns (measured on 20T signal) >34 dB
C/L gain	$+2\%$ / -2%
C/L delay	$+2\%$ / -5%
Return loss (0 to 6 MHz)	$+2\%$ / -15%
Frequency response (typical values, measured with multiburst signal)	
0 MHz to 3 MHz	$+2\%$ / -2%
<4 MHz	$+2\%$ / -5%
<5 MHz	$+2\%$ / -15%
Video serial digital 270 Mbit/s (SDI, to ITU-R 601/656 or SMPTE259M)	BNC connector on rear panel 800 mV (V_{pp}), 75 Ω
Audio	unbalanced, not floating
Level (full scale)	6/9/12/15 dBu ± 0.5 dB
Frequency response (60 Hz to 15 kHz)	± 0.5 dB relative to 1 kHz, into 600 Ω
S/N ratio	>70 dB, unweighted
THD	>70 dB
Audio left, audio right	LEMO Triax connectors on rear panel <50 Ω
Audio serial digital (AES/EBU)	LEMO Triax connectors on rear panel 4 V (V_{pp}), 110 Ω

Operation

Manual control	front-panel keys with LC display, output of test results on LCD as well as text inserted in video output signal
Remote control	via RS232 interface or Ethernet (network)

Interfaces

Serial interface	9-pin sub-D connector on rear panel RS232, 9600 to 115 000 baud, remote control, SCPI commands
Parallel interface	25-pin sub-D connector on rear panel printer output
Network	RJ45 connector on rear panel Ethernet, 10BaseT, 10 Mbit/s remote control, system integration
Protocols	TCP/IP, SNMP
Relay outputs Number	15-pin VGA connector on rear panel 12 with any allocation to events, ORed in case of allocation to several events separately selectable (open or closed)
Active state	

Test parameters

Events	sound loss left sound loss right picture loss picture freeze quality below (user-selectable) threshold
--------	--

Recording

Statistics	error seconds of events according to type display selectable according to type listing of events according to time optional filtering according to type display per entry: time, duration, PID, type
Report	temporal activity spatial activity digital video quality level, unweighted (DVQL-U), separately for luminance and chrominance (Y, C_b , C_r) digital video quality level, weighted (DVQL-W) total level corresponding to subjective assessment
Video data analysis	

Display

Current values	bargraph numeric values
Recorded values	time profile histogram
Time frame for recording	5 s, 10 s, 30 s, 1 min, 5 min, 10 min, 30 min, 1 h, 2 h, 5 h single-shot or continuous
Reference measurement	
Delay	± 5 s, automatically detected



CA Descrambler Options DVQ-B1x

Signal input

MPEG2 transport stream	to ISO/IEC 13818-1
Asynchronous serial	BNC connector on rear panel
270 Mbit/s (ASI, to DVB-A010)	200 mV to 1 V (V_{pp}), 75 Ω
Data rate	up to 50 Mbit/s

Signal output

MPEG2 transport stream	to ISO/IEC 13818-1
Asynchronous serial	BNC connector on rear panel
270 Mbit/s (ASI, to DVB-A010)	800 mV (V_{pp}), 75 Ω
Data rate	same as input data rate

General data

Rated temperature range	+5 °C to +40 °C
Operating temperature range	0 °C to +45 °C
Storage temperature range	-40 °C to +70 °C
Mechanical resistance	
Vibration, sinusoidal	5 Hz to 150 Hz, max. 2 g at 55 Hz, max. 0.5 g in range 55 Hz to 150 Hz, meets IEC 68-2-6, IEC 1010-1 and MIL-T-28800 D class 5
Vibration, random	10 Hz to 300 Hz, acceleration 1.2 g (rms)
Shock	40 g shock spectrum, meets MIL-STD-810 D and MIL-T-28800 D class 3 and 5
Climatic resistance	95% rel. humidity, cyclic test at +25 °C / +40 °C, meets IEC 68-2-30
Electromagnetic compatibility	meets EN 50081-2 and 50082-2 (EMC directive of EU)
Power supply	100 V to 240 V \pm 10%, 50 Hz to 60 Hz \pm 5%
Power consumption	20 W (without options)
Electrical safety	meets EN 61010-1
Dimensions (W x H x D)	427 mm x 88 mm x 450 mm
Weight	5.7 kg (without options)

Ordering information

Digital Video Quality Analyzer	DVQ	2079.6003.03
Accessories supplied		power cable, operating manual, audio adapter (LEMO Triax to XLR), modem bypass cable

Options

Quality Explorer™ Software	DVQ-B1	2079.7151.02
Quality Monitor™ Software		available free of charge at www.rohde-schwarz.com
SMPT310 Input	DV-B310	2085.7543.02
Descrambling options for CA systems		
Conax, Nagravision, Viaccess	DVQ-B10	2079.7568.02
Irdeto	DVQ-B11	2079.7574.02
SECA-Mediaguard	DVQ-B12	2079.7580.02
NDS-Videoguard (BSkyB)	DVQ-B15	2079.7516.02
Betacrypt BetaDigital	DVQ-B16	2079.7522.02
Betacrypt DTAG	DVQ-B16	2079.7522.03
Betacrypt ORF	DVQ-B16	2079.7522.04
Cryptoworks	DVQ-B17	2079.7539.02
Calibration Data Documentation	DVQ-DCV	2082.0490.20

Recommended extras

Common Interface Adapter TSout	SFQ-Z17	2081.9364.02
19" Rack Adapter (2HU)	ZZA-211	1096.3260.00
for installation with handles (rackmount without handles on request)		
Service Manual		2079.7951.24

(*) see data sheet PD 757.5450



ROHDE & SCHWARZ

ROHDE & SCHWARZ GmbH & Co. KG · Mühldorfstrasse 15 · 81671 München · Germany · P.O.B. 8014 69 · 81614 München · Germany · Telephone +49894129-0
www.rohde-schwarz.com · CustomerSupport: Tel. +49 1805124242, Fax +4989 4129-13777, E-mail: CustomerSupport@rohde-schwarz.com